

aerospace  
climate control  
electromechanical  
filtration  
fluid & gas handling  
hydraulics  
pneumatics  
process control  
sealing & shielding



# Parker Angle Body Valves

PA Series, 2-Way, NC or NO,  
3/8" to 2 1/2" NPT, 232 PSI



ENGINEERING YOUR SUCCESS.



# Parker Angle Body Valves

## Introduction

An angle body valve is actuated by a pneumatically driven piston and is capable of handling slurry solutions with particles or corrosive solutions at high temperature up to 356°F and operating pressure up to 232 PSI.

## Benefits

- Compact design, high flow rates with Cv's up to 81.7
- Visual position indicator
- For temperatures from 14°F to 356°F
- Working pressures up to 232 PSI
- Dampened closing Anti-Water Hammer design (fluid under seat)
- Stainless Steel actuator housing for exceptional durability in steam and aggressive applications
- Valves meeting Pressure Equipment Directive 97/23/EC
- Mountable in any position
- Tight shut-off and Long Service Life
- Parker Angle Body Valves conform to the terms of the 94/9/CE directive specific to non electrical equipment for use within potentially explosive environments - zone 2/22

## Applications

**Angle body valves are suitable for many process and industrial applications:**

- Food and Beverage Processing
- Water Technology & Treatment
- Textile Industry
- Cooling systems on injection molding machines
- Pharmaceutical & cosmetic industry
- Chemical Process technology
- Refrigeration & Cooling heat exchangers
- Sterilizers steam supply
- Water applications: Mining, Cement / Concrete Systems, Pulp & Paper
- General industrial applications of aggressive fluids
- Industrial Laundry Equipment
- Industrial Air Dryers

# Table of Contents

Parker Angle Body Valves		page
<b>Key Features</b>		4
<b>General Specifications</b>		5
<b>Normally Closed</b>	Flow Direction Over the Seat	6
<b>Normally Open</b>	Flow Direction Under the Seat	8
<b>Normally Closed</b>	Flow Direction Under the Seat Anti-Water Hammer Construction	10
<b>Compact Design Normally Closed</b>	Flow Direction Over Seat	11
<b>Compact Design Normally Closed</b>	Flow Direction Under Seat	12
<b>Drawings and Dimensions</b>		13
<b>Numbering System</b>		14
<b>Solenoid Pilot Valves</b>	for Controlling the PA Series Angle Body Valves	15



## WARNING – USER RESPONSIBILITY

FAILURE OR IMPROPER SELECTION OR IMPROPER USE OF THE PRODUCTS AND/OR SYSTEMS DESCRIBED HEREIN OR RELATED ITEMS CAN CAUSE DEATH, PERSONAL INJURY AND PROPERTY DAMAGE.

This document and other information from Parker-Hannifin Corporation, its subsidiaries and authorized distributors provide product and/or system options for further investigation by users having technical expertise. It is important that you analyze all aspects of the application, follow applicable industry standards, and follow the information concerning the product in the current product catalog and in any other materials provided from Parker or its subsidiaries or authorized distributors. Due to the variety of operating conditions and applications for these products or systems, the user, through its own analysis and testing, is solely responsible for making the final selection of the system and components and assuring that all performance, endurance, maintenance, safety and warning requirements of the application are met.

To the extent that Parker or its subsidiaries or authorized distributors provide component or system options based upon data or specifications provided by the user, the user is responsible for determining that such data and specifications are suitable and sufficient for all applications and reasonably foreseeable uses of the components or systems.

The product described herein, including without limitation, product features, specifications, designs, availability and pricing, are subject to change by Parker Hannifin Corporation and its subsidiaries at any time without notice.

# Key Features

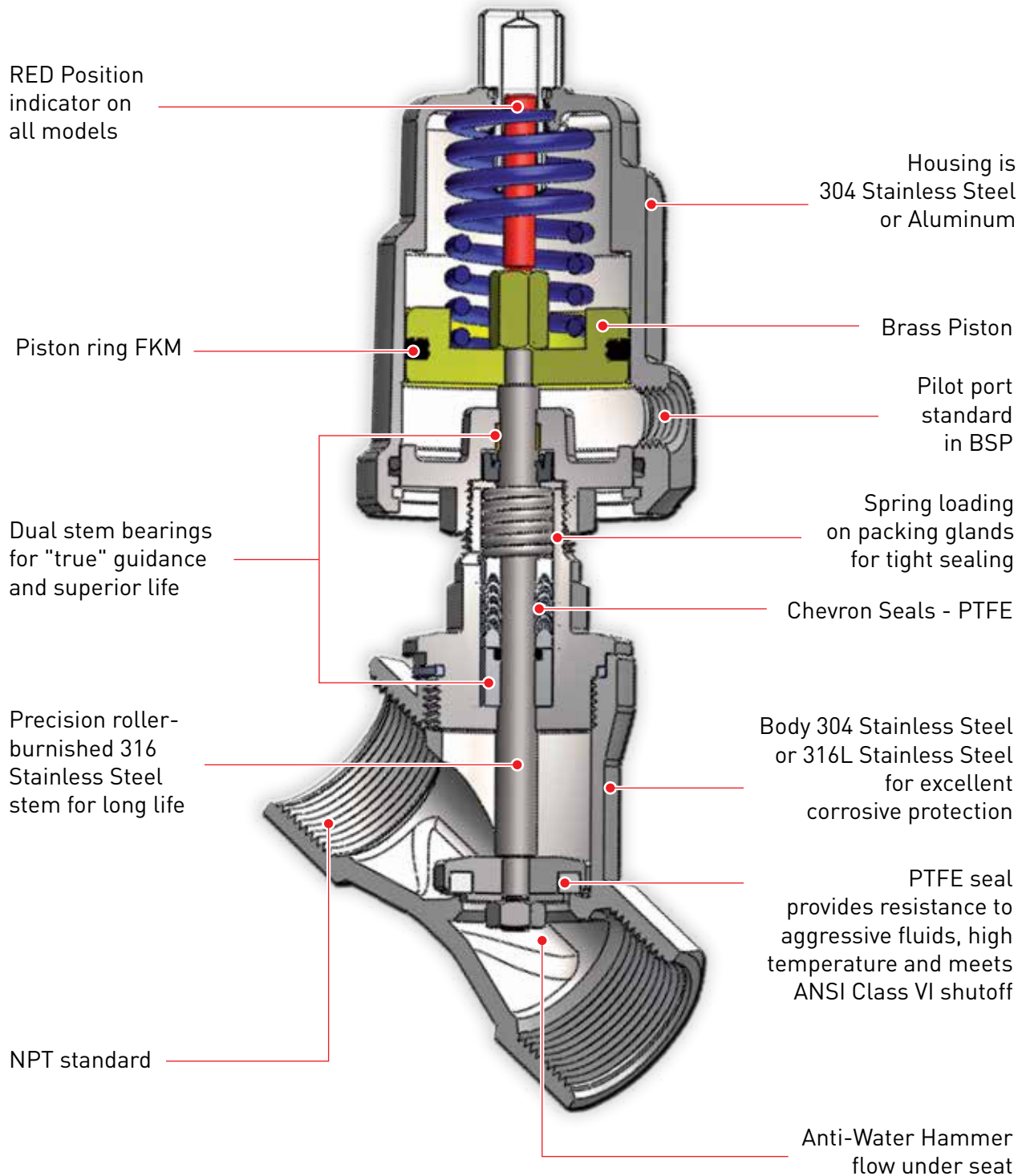



# General Specifications

## PA Series, 2-Way, NC or NO, 3/8" to 2 1/2" NPT, 232 PSI



**For liquids, use versions with flow direction under the seat.**

- Body Material 304 Stainless Steel or 316 Stainless Steel
- Actuator Material 304 Stainless Steel, or Aluminum
- Function 2-Way, NC, NO, NC (Anti-Water Hammer)
- Port size from 3/8" to 2 1/2"
- Body Port Connections: Threads NPT
- Maximum Working Pressure 232 PSI
- Flow factor 5.5 CV TO 81.7 CV
- The PA Series angle body valves comply with European Pressure Equipment Directive 97/23/EC
- Parker Angle Body Valves conform to the terms of the 94/9/CE directive specific to non electrical equipment for use within potentially explosive environments - Zone 2/22 - Protection II 3 GD T4
- Pilot Pressure 44 PSI min to 145 PSI max according to control pressure charts
- Fluid Temperature 14°F to 356°F
- Ambient Temperature 14°F to 140°F
- Seat Seal material PTFE
- Packing Gland: PTFE and PTFE with Carbon
- Installs in Any Position
- Optical Position Indicator Standard on all sizes
- Pilot Control Media Air, Neutral Gas
- Fluids handled: Inert gases, hot water, oils, steam, aggressive and corrosive fluids
- Weight from 1.39 - 19.03 lbs
- Viscosity: Maxi. 600 mm<sup>2</sup>/s (600cSt, 80° E, 2700 SSU)

### Accessories

- 3 Way Direct Acting AC & DC Pilot Control Valves available as separate components

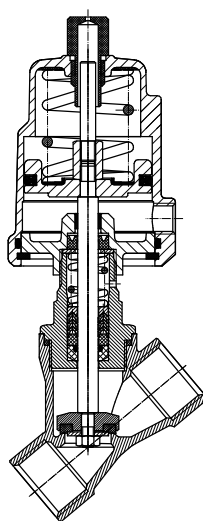

Normally Closed Valve

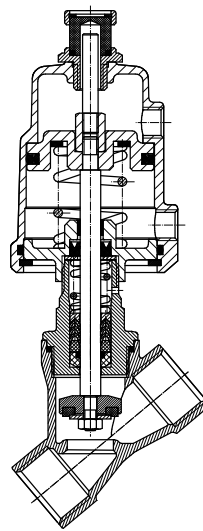

Normally Open Valve



# PA Series Normally Closed Valves - Flow Direction OVER Seat

Model numbers shown are NPT threads



## 304 Stainless Steel Bodies with Aluminum Actuators

Valve Size	Port Size NPT	Orifice in	CV	Actuator			Operating Pressure - Air, Inert Gases		Operating Pressure - Steam		Minimum Pilot Control Pressure Range		Model Number	Net Weight Lb
				dia mm	dia in	Port bsp	PSI	bar	PSI	bar	PSI	bar		
3/8"	3/8"	0.51	5.5	50	1.97	1/8	0 - 232	0 - 16	0 - 130	0 - 8.9	43.5	3	PA10S1N3S050A	1.65
1/2"	1/2"	0.51	5.5	50	1.97	1/8	0 - 232	0 - 16	0 - 130	0 - 8.9	43.5	3	PA15S1N4S050A	1.76
3/4"	3/4"	0.71	10.5	50	1.97	1/8	0 - 232	0 - 16	0 - 130	0 - 8.9	43.5 - 58	3 - 4	PA20S1N5S050A	1.98
1"	1"	0.94	18.7	50	1.97	1/8	0 - 232	0 - 16	0 - 130	0 - 8.9	43.5 - 80	3 - 5.5	PA25S1N6S050A	2.79
			18.7	63	2.48	1/8	0 - 232	0 - 16	0 - 130	0 - 8.9	43.5 - 58	3 - 4	PA25S1N6S063A	3.63
1-1/4"	1-1/4"	1.22	28.0	63	2.48	1/8	0 - 232	0 - 16	0 - 130	0 - 8.9	43.5 - 80	3 - 5.5	PA32S1N7S063A	4.16
1-1/2"	1-1/2"	1.38	37.3	63	2.48	1/8	0 - 232	0 - 16	0 - 130	0 - 8.9	43.5 - 94.3	3 - 6.5	PA40S1N8S063A	4.73
			58.3	63	2.48	1/8	0 - 145	0 - 10	0 - 130	0 - 8.9	43.5 - 94.3	3 - 6.5	PA50S1N9S063A	6.56
2"	2"	1.77	58.3	80	3.15	1/4	0 - 232	0 - 16	0 - 130	0 - 8.9	43.5 - 95.7	3 - 6.6	PA50S1N9S080A	7.83
			58.3	100	3.94	1/4	0 - 232	0 - 16	0 - 130	0 - 8.9	43.5 - 72.5	3 - 5	PA50S1N9S100A	10.45
2-1/2"	2-1/2"	2.56	81.7	100	3.94	1/4	0 - 145	0 - 10	0 - 130	0 - 8.9	43.5 - 87	3 - 6	PA65S1N1S100A	12.10

## 316L Stainless Steel Bodies with 304 Stainless Steel Actuators

Valve Size	Port Size NPT	Orifice in	CV	Actuator			Operating Pressure - Air, Inert Gases		Operating Pressure - Steam		Minimum Pilot Control Pressure Range		Model Number	Net Weight Lb
				dia mm	dia in	Port bsp	PSI	bar	PSI	bar	PSI	bar		
3/8"	3/8"	0.51	5.5	40	1.57	1/8	0 - 232	0 - 16	0 - 130	0 - 8.9	58.0	4	PA10S1N3R040S	1.72
			5.5	50	1.97	1/8	0 - 232	0 - 16	0 - 130	0 - 8.9	43.5	3	PA10S1N3R050S	2.22
1/2"	1/2"	0.51	5.5	40	1.57	1/8	0 - 232	0 - 16	0 - 130	0 - 8.9	58.0	4	PA15S1N4R040S	1.76
			5.5	50	1.97	1/8	0 - 232	0 - 16	0 - 130	0 - 8.9	43.5	3	PA15S1N4R050S	2.27
3/4"	3/4"	0.71	10.5	50	1.97	1/8	0 - 232	0 - 16	0 - 130	0 - 8.9	43.5 - 58.0	3 - 4	PA20S1N5R050S	2.33
1"	1"	0.94	18.7	50	1.97	1/8	0 - 232	0 - 16	0 - 130	0 - 8.9	43.5 - 80	3 - 5.5	PA25S1N6R050S	3.04
			18.7	63	2.48	1/8	0 - 232	0 - 16	0 - 130	0 - 8.9	43.5 - 50.8	3 - 3.5	PA25S1N6R063S	4.51
1-1/4"	1-1/4"	1.22	28.0	63	2.48	1/8	0 - 232	0 - 16	0 - 130	0 - 8.9	43.5 - 72.5	3 - 5	PA32S1N7R063S	5.28
1-1/2"	1-1/2"	1.38	37.3	63	2.48	1/8	0 - 232	0 - 16	0 - 130	0 - 8.9	43.5 - 87	3 - 6	PA40S1N8R063S	6.05
			58.3	63	2.48	1/8	0 - 145	0 - 10	0 - 130	0 - 8.9	43.5 - 94.3	3 - 6.5	PA50S1N9R063S	7.70
2"	2"	1.77	58.3	80	3.15	1/4	0 - 232	0 - 16	0 - 130	0 - 8.9	43.5 - 95.7	3 - 6.6	PA50S1N9R080S	10.16
			58.3	100	3.94	1/4	0 - 232	0 - 16	0 - 130	0 - 8.9	43.5 - 72.5	3 - 5	PA50S1N9R100S	11.35
2-1/2"	2-1/2"	2.56	81.7	100	3.94	1/4	0 - 145	0 - 10	0 - 130	0 - 8.9	43.5 - 87	3 - 6	PA65S1N1R100S	19.03

## Normally Closed Valves - Flow Direction OVER Seat

## PA Series

### Control Pressure & Operating Pressure Charts for the Normally Closed Valves with 304 Stainless Steel Actuators

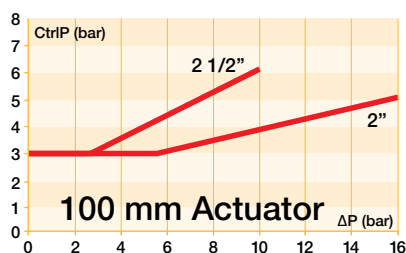
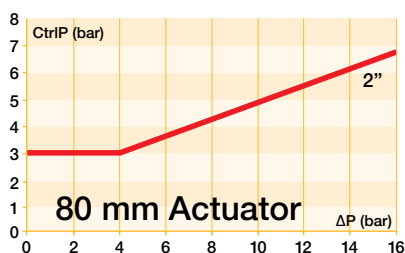
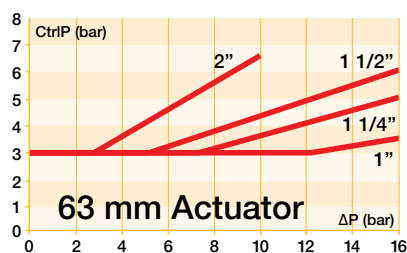
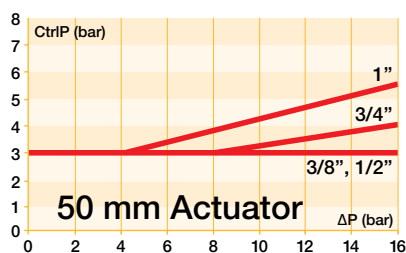
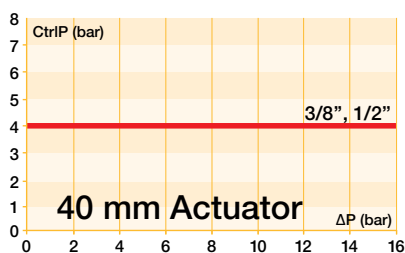

### Flow Diagram

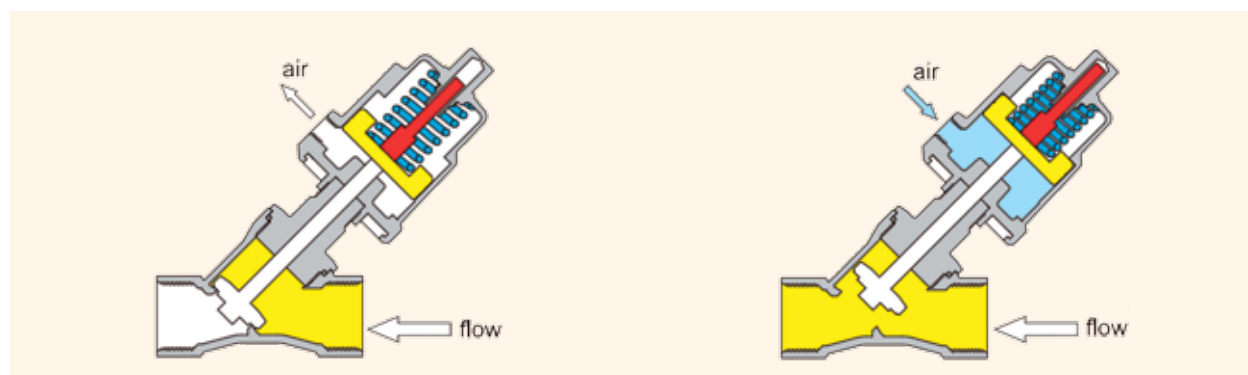

Valve Closed

Valve Open

# PA Series Normally Open Valves - Flow Direction UNDER Seat

Model numbers shown are NPT threads

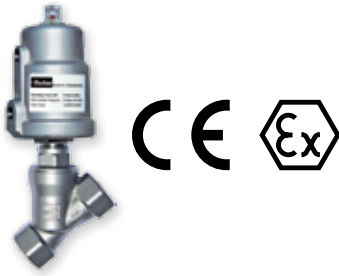

## 304 Stainless Steel Bodies with Aluminum Actuators

Valve Size	Port Size NPT	Orifice in	CV	Actuator			Operating Pressure - Air, Inert Gases, Liquids		Operating Pressure - Steam		Minimum Pilot Control Pressure Range		Model Number	Net Weight Lb
				dia mm	dia in	Port bsp	PSI	bar	PSI	bar	PSI	bar		
3/8"	3/8"	0.51	5.5	50	1.97	1/8	0 - 232	0 - 16	0 - 130	0 - 8.9	50.8	3.5	PA10S3N3S050A	1.65
1/2"	1/2"	0.51	5.5	50	1.97	1/8	0 - 232	0 - 16	0 - 130	0 - 8.9	50.8	3.5	PA15S3N4S050A	1.76
3/4"	3/4"	0.71	11.1	50	1.97	1/8	0 - 232	0 - 16	0 - 130	0 - 8.9	50.8	3.5	PA20S3N5S050A	1.98
1"	1"	0.94	18.1	63	2.48	1/8	0 - 232	0 - 16	0 - 130	0 - 8.9	65.3	4.3	PA25S3N6S063A	3.63
1-1/4"	1-1/4"	1.22	27.0	80	3.15	1/4	0 - 232	0 - 16	0 - 130	0 - 8.9	43.5	3	PA32S3N7S080A	6.16
1-1/2"	1-1/2"	1.38	36.2	80	3.15	1/4	0 - 232	0 - 16	0 - 130	0 - 8.9	43.5	3	PA40S3N8S080A	6.82
2"	2"	1.77	58.3	80	3.15	1/4	0 - 232	0 - 16	0 - 130	0 - 8.9	43.5	3	PA50S3N9S080A	7.83

## 316L Stainless Steel Bodies with 304 Stainless Steel Actuators

Valve Size	Port Size NPT	Orifice in	CV	Actuator			Operating Pressure - Air, Inert Gases, Liquids		Operating Pressure - Steam		Minimum Pilot Control Pressure Range		Model Number	Net Weight Lb
				dia mm	dia in	Port bsp	PSI	bar	PSI	bar	PSI	bar		
3/8"	3/8"	0.51	5.5	50	1.97	1/8	0 - 232	0 - 16	0 - 130	0 - 8.9	50.8	3.5	PA10S3N3R050S	2.22
1/2"	1/2"	0.51	5.5	50	1.97	1/8	0 - 232	0 - 16	0 - 130	0 - 8.9	50.8	3.5	PA15S3N4R050S	2.27
3/4"	3/4"	0.71	11.1	50	1.97	1/8	0 - 232	0 - 16	0 - 130	0 - 8.9	50.8	3.5	PA20S3N5R050S	2.33
1"	1"	0.94	18.1	63	2.48	1/8	0 - 232	0 - 16	0 - 130	0 - 8.9	65.3	4.3	PA25S3N6R063S	4.51
1-1/4"	1-1/4"	1.22	27.0	80	3.15	1/4	0 - 232	0 - 16	0 - 130	0 - 8.9	43.5	3	PA32S3N7R080S	8.40
1-1/2"	1-1/2"	1.38	36.2	80	3.15	1/4	0 - 232	0 - 16	0 - 130	0 - 8.9	43.5	3	PA40S3N8R080S	8.91
2"	2"	1.77	58.3	80	3.15	1/4	0 - 232	0 - 16	0 - 130	0 - 8.9	43.5	3	PA50S3N9R080S	10.16



# Normally Open Valves - Flow Direction UNDER Seat

# PA Series

## Control Pressure & Operating Pressure Charts for the Normally Open Valves

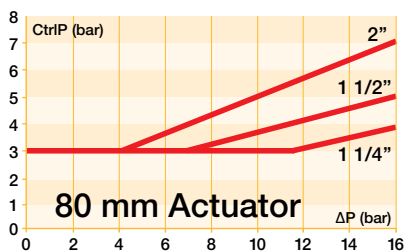
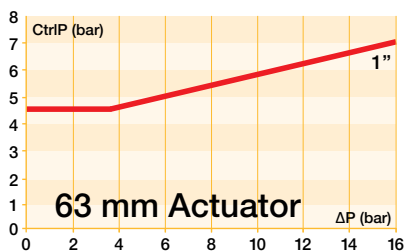
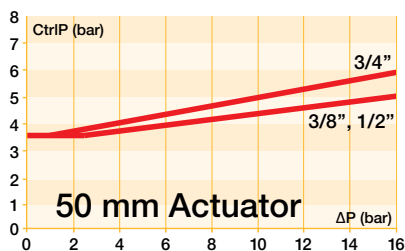

## Flow Diagram

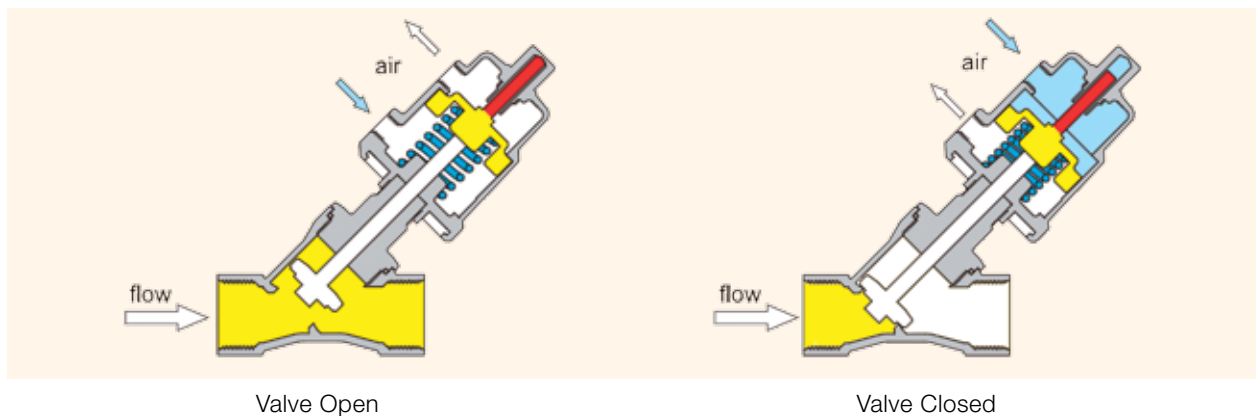

# PA Series Normally Closed Valves - Flow Direction UNDER Seat

Anti-Water Hammer Construction Model numbers shown are NPT threads



## 304 Stainless Steel Bodies with Aluminum Actuators

Valve Size in	Port Size NPT	Orifice in	CV	Actuator			Operating Pressure - Air, Inert Gas, Liquids		Operating Pressure - Steam		Minimum Pilot Control Pressure Range		Model Number	Net Weight Lb
				dia mm	dia in	Port bsp	PSI	bar	PSI	bar	PSI	bar		
3/8"	3/8"	0.51	5.5	50	1.97	1/8	0 - 232	0 - 16	N/A	N/A	65.3	4.5	PA10SAN3S050A	1.65
1/2"	1/2"	0.51	5.5	50	1.97	1/8	0 - 232	0 - 16	N/A	N/A	65.3	4.5	PA15SAN4S050A	1.76
3/4"	3/4"	0.71	10.5	50	1.97	1/8	0 - 145	0 - 10	N/A	N/A	65.3	4.5	PA20SAN5S050A	1.98
1"	1"	0.94	18.7	63	2.48	1/8	0 - 116	0 - 8	N/A	N/A	65.3	4.5	PA25SAN6S063A	3.63
1-1/4"	1-1/4"	1.22	28.0	80	3.15	1/4	0 - 160	0 - 11	N/A	N/A	58.0	4	PA32SAN7S080A	6.16
				100	3.94	1/4	0 - 232	0 - 16	N/A	N/A	58.0	4	PA40SAN8S100A	9.13
1-1/2"	1-1/2"	1.38	37.3	80	3.15	1/4	0 - 116	0 - 8	N/A	N/A	58.0	4	PA40SAN8S080A	6.82
				100	3.94	1/4	0 - 232	0 - 16	N/A	N/A	58.0	4	PA40SAN8S100A	9.13
2"	2"	1.77	58.3	100	3.94	1/4	0 - 130	0 - 8.9	N/A	N/A	58.0	4	PA50SAN9S100A	10.45

## 316L Stainless Steel Bodies with 304 Stainless Steel Actuators

Valve Size in	Port Size NPT	Orifice in	CV	Actuator			Operating Pressure - Air, Inert Gas, Liquids		Operating Pressure - Steam		Minimum Pilot Control Pressure Range		Model Number	Net Weight Lb
				dia mm	dia in	Port bsp	PSI	bar	PSI	bar	PSI	bar		
3/8"	3/8"	0.51	5.5	50	1.97	1/8	0 - 232	0 - 16	N/A	N/A	65.3	4.5	PA10SAN3R050S	2.22
1/2"	1/2"	0.51	5.5	50	1.97	1/8	0 - 232	0 - 16	N/A	N/A	65.3	4.5	PA15SAN4R050S	2.27
3/4"	3/4"	0.71	10.5	50	1.97	1/8	0 - 145	0 - 10	N/A	N/A	65.3	4.5	PA20SAN5R050S	2.33
1"	1"	0.94	18.7	63	2.48	1/8	0 - 116	0 - 8	N/A	N/A	65.3	4.5	PA25SAN6R063S	4.51
1-1/4"	1-1/4"	1.22	28.0	80	3.15	1/4	0 - 160	0 - 11	N/A	N/A	58.0	4	PA32SAN7R080S	8.40
				100	3.94	1/4	0 - 232	0 - 16	N/A	N/A	58.0	4	PA40SAN8R100S	10.14
1-1/2"	1-1/2"	1.38	37.3	80	3.15	1/4	0 - 116	0 - 8	N/A	N/A	58.0	4	PA40SAN8R080S	8.95
				100	3.94	1/4	0 - 232	0 - 16	N/A	N/A	58.0	4	PA40SAN8R100S	10.14
2"	2"	1.77	58.3	100	3.94	1/4	0 - 130	0 - 8.9	N/A	N/A	58.0	4	PA50SAN9R100S	11.35

## Flow Diagram

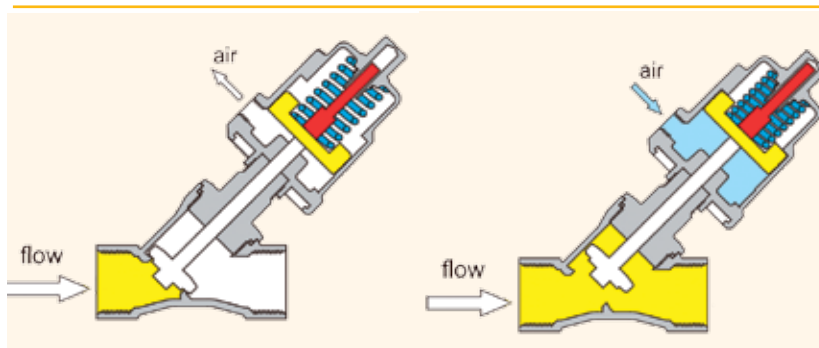

Valve Closed

Valve Open

## Control Pressure & Operating Pressure

Charts do not apply for Valves with flow direction Under Seat. A minimum pressure as noted above is all that is required, up to 145 psi maximum.

# PA Series Compact Design Normally Closed Valves - Flow Direction Over Seat

Model numbers shown are NPT threads



## 316L Stainless Steel Bodies with 304 Stainless Steel Actuators

Valve Size	Port Size	Orifice	CV	Actuator			Operating Pressure - Air, Inert Gases		Operating Pressure - Steam		Minimum Pilot Control Pressure Range		Model Number	Net Weight
				dia mm	dia in	Port bsp	PSI	bar	PSI	bar	PSI	bar		
3/8"	3/8"	0.51	5.5	32	1.26	1/8	0 - 232	0 - 16	0 - 130	0 - 8.9	65.3 - 87	4.5 - 6	PA10C1N3R032S	1.39
1/2"	1/2"	0.51	5.5	32	1.26	1/8	0 - 232	0 - 16	0 - 130	0 - 8.9	65.3 - 87	4.5 - 6	PA15C1N4R032S	1.43
3/4"	3/4"	0.59	6.3	32	1.26	1/8	0 - 203	0 - 14	0 - 130	0 - 8.9	65.3 - 87	4.5 - 6	PA20C1N5R032S	1.56

## Control Pressure & Operating Pressure

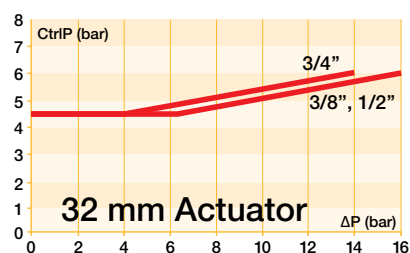

## Flow Diagram

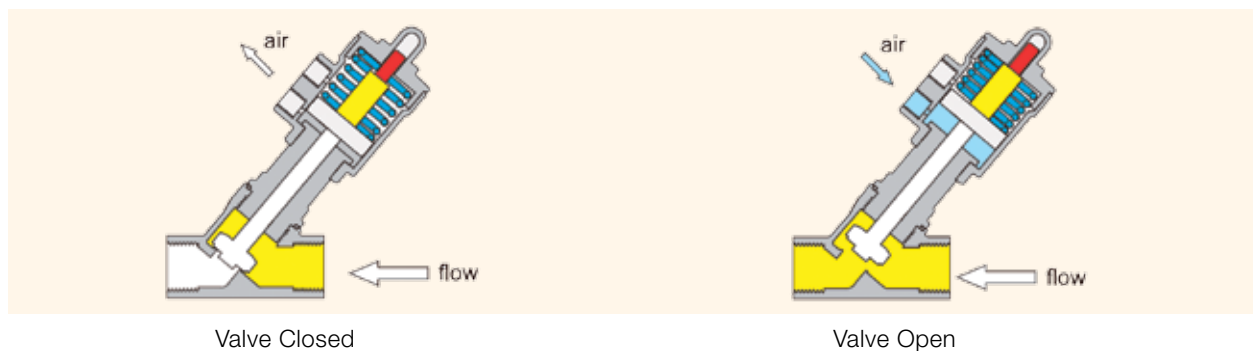

# PA Series Compact Design Normally Closed Valves-Flow direction Under Seat

Model numbers shown are NPT threads



## 304 Stainless Steel Actuators with 316L Stainless Steel Bodies

Valve Size	Port Size	Orifice	CV	Actuator			Operating Pressure - Air, Inert Gases, Liquids		Operating Pressure - Steam		Minimum Pilot Control Pressure Range		Model Number	Net Weight
				dia mm	Port in	bsp	PSI	bar	PSI	bar	PSI	bar		
3/8"	3/8"	0.51	5.5	32	1.26	1/8	0 - 87	0 - 6	N/A	N/A	73 - 87	5 - 6	PA10C2N3R032S	1.39
1/2"	1/2"	0.51	5.5	32	1.26	1/8	0 - 87	0 - 6	N/A	N/A	73 - 87	5 - 6	PA15C2N4R032S	1.43
3/4"	3/4"	0.59	6.3	32	1.26	1/8	0 - 58	0 - 4	N/A	N/A	73 - 87	5 - 6	PA20C2N5R032S	1.56

## Control Pressure & Operating Pressure

Charts do not apply for Valves with flow direction Under Seat. A minimum pressure as noted above is all that is required, up to 145 psi maximum.

## Flow Diagram

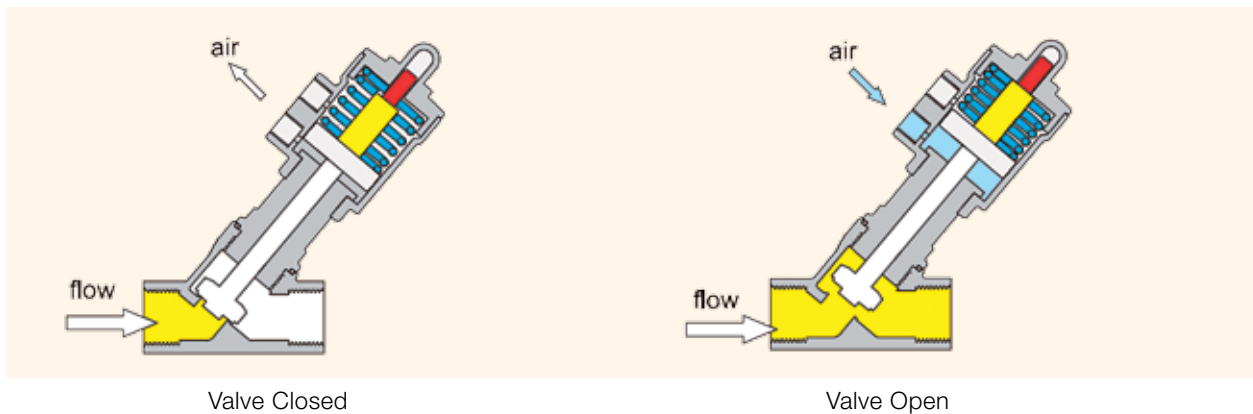

# Drawings and Dimensioning System

## Stainless Steel Actuators Sizes 40, 50, 63, 80, 100 mm

Type	Actuator mm	D in	R in	P bsp	K1 in	A1 in	G NPT	L in	T in	SW in	
DN10 (3/8")	40	1.99	1.06	G1/8	4.57	4.76	3/8	2.36	0.39	.87	hexagon
	50	2.44	1.34	G1/8	5.12	5.24	3/8	2.36	0.39	.87	hexagon
DN15 (1/2")	40	1.99	1.06	G1/8	4.65	4.88	1/2	2.56	0.45	.98	hexagon
	50	2.44	1.34	G1/8	5.16	5.31	1/2	2.56	0.45	.98	hexagon
DN 20 (3/4")	50	2.44	1.34	G1/8	5.28	5.55	3/4	2.95	0.55	1.22	hexagon
DN25 (1")	50	2.44	1.34	G1/8	5.55	6.02	1	3.54	0.59	1.53	hexagon
	63	3.03	1.63	G1/8	6.46	6.89	1	3.54	0.59	1.53	hexagon
DN32 (1-1/4")	63	3.03	1.63	G1/8	6.69	7.40	1-1/4	4.33	0.71	1.97	octagon
	80	3.86	2.05	G1/4	7.24	8.07	1-1/4	4.33	0.71	1.97	octagon
DN40 (1-1/2")	63	3.03	1.63	G1/8	7.13	7.91	1-1/2	4.72	0.71	2.20	octagon
	80	3.86	2.05	G1/4	7.68	8.54	1-1/2	4.72	0.71	2.20	octagon
	100	4.76	2.48	G1/4	8.39	9.25	1-1/2	4.72	0.71	2.20	octagon
DN50 (2")	63	3.03	1.63	G1/8	7.44	8.50	2	5.91	0.87	2.68	octagon
	80	3.86	2.05	G1/4	7.99	9.17	2	5.91	0.87	2.68	octagon
DN65 (2-1/2")	100	4.76	2.48	G1/4	8.70	9.84	2	5.91	0.87	2.68	octagon
	100	4.76	2.48	G1/4	9.76	11.22	2-1/2	7.09	0.98	3.35	octagon

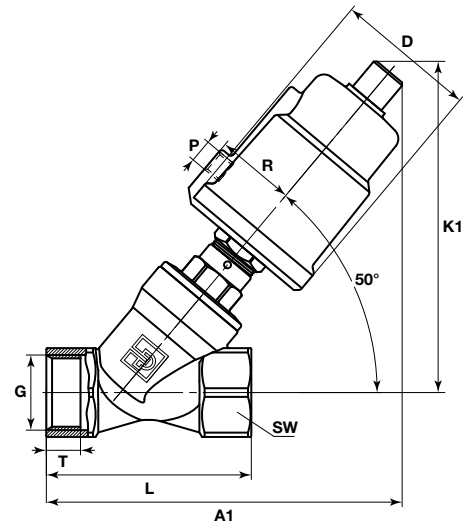

## Aluminum Actuators Sizes 50, 63, 80, 100 mm

Type	Actuator mm	D in	R in	P bsp	K1 in	A1 in	G NPT	L in	T in	SW in	
DN10 (3/8")	50	2.40	1.50	G1/8	5.20	5.55	3/8	2.36	0.39	.87	hexagon
DN15 (1/2")	50	2.40	1.50	G1/8	5.24	5.67	1/2	2.56	0.45	.98	hexagon
DN20 (3/4")	50	2.40	1.50	G1/8	5.35	5.91	3/4	2.95	0.55	1.22	hexagon
DN25 (1")	50	2.40	1.50	G1/8	5.67	6.38	1	3.54	0.59	1.53	hexagon
	63	2.95	1.77	G1/8	6.57	7.20	1	3.54	0.59	1.53	hexagon
DN32 (1-1/4")	63	2.95	1.77	G1/8	6.81	7.72	1-1/4	4.33	0.71	1.97	hexagon
	80	3.70	2.13	G1/4	7.56	8.43	1-1/4	4.33	0.71	1.97	hexagon
DN40 (1-1/2")	63	2.95	1.77	G1/8	7.24	8.23	1-1/2	4.72	0.71	2.20	octagon
	80	3.70	2.13	G1/4	7.99	8.90	1-1/2	4.72	0.71	2.20	octagon
	100	4.53	2.52	G1/4	8.78	9.65	1-1/2	4.72	0.71	2.20	octagon
DN50 (2")	63	2.95	1.77	G1/8	7.56	8.82	2	5.91	0.87	2.68	octagon
	80	3.70	2.13	G1/4	8.31	9.53	2	5.91	0.87	2.68	octagon
DN65 (2-1/2")	100	4.53	2.52	G1/4	9.09	10.24	2	5.91	0.87	2.68	octagon
	100	4.53	2.52	G1/4	10.12	11.57	2-1/2	7.09	0.98	3.35	octagon

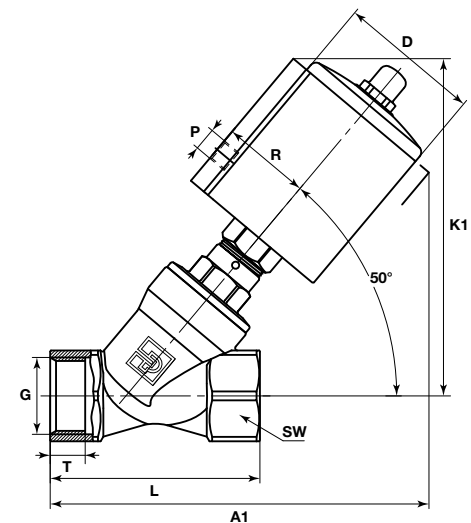

## Stainless Steel Actuators Size 32 mm

Type	Actuator mm	Ø B in	R in	G1 bsp	K2 in	A2 in	G NPT	L in	T in	SW in	
DN10 (3/8")	32	1.56	1.06	G1/8	4.21	4.61	3/8	2.36	0.39	.87	hexagon
DN15 (1/2")	32	1.56	1.06	G1/8	4.29	4.69	1/2	2.56	0.45	.98	hexagon
DN20 (3/4")	32	1.56	1.06	G1/8	4.41	4.96	3/4	2.95	0.55	1.22	hexagon

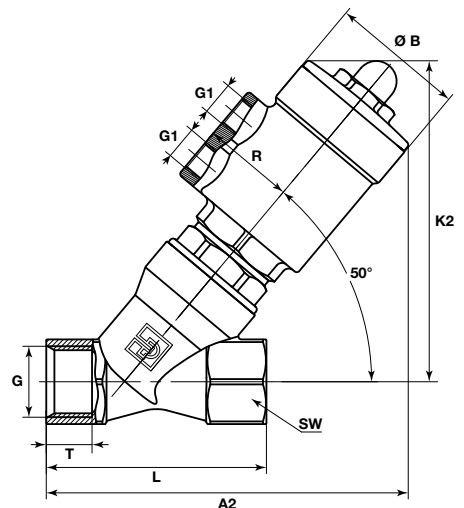



# Numbering System

## Angle Body Valve Numbering System

PA	25	SA	N6	S	063A	-
Series	Valve Size	Valve Type/Series	Body Thread Standard*	Body Material	Actuator Description	Special
	mm (in)					
PA	10 (3/8")	S1 NC, flow over seat	N3 3/8 NPT	S 304 SS	<b>Stainless Steel 304</b>	
PA	15 (1/2")	S3 NO, flow under seat	N4 1/2 NPT	R 316L SS	032S 32 mm actuator	
PA	20 (3/4")	SA NC, flow under seat, Anti-Water Hammer	N5 3/4 NPT		040S 40 mm actuator	
PA	25 (1")	C1 Compact NC, flow over seat	N6 1 NPT		050S 50 mm actuator	
PA	32 (1-1/4")	C2 Compact NC, flow under seat	N7 1-1/4 NPT		063S 63 mm actuator	
PA	40 (1-1/2")		N8 1-1/2 NPT		080S 80 mm actuator	
PA	50 (2")		N9 2 NPT		100S 100 mm actuator	
PA	65 (2-1/2")		NT 2-1/2 NPT			
						<b>Aluminum</b>
						040A 40 mm actuator
						050A 50 mm actuator
						063A 63 mm actuator
						080A 80 mm actuator
						100A 100 mm actuator

**Example:** PA25SAN6S063A - 1" 304 Stainless Steel body valve, 2 Way Normally Closed, Flow Under Seat for Anti-Water Hammer, NPT ports, with 63 mm Aluminum actuator

\* For other body port options, consult factory.

# Banjo Pilot Valve $3/2$ normally closed solenoid valve



**For air actuation of process and Industrial control valves**  
Parker Fluid Control Division's 3-way normally closed Banjo valve offers an ideal complement to our angle body product line. The valve is offered standard with a DIN plug and cable gland connector for a cost-effective installation. To meet your requirements, the valve is available in a modular design or fully assembled.

## Features

- Direct mounting to angle body valve actuator with banjo bolt
- Standard locking manual override
- Din coil freely rotatable
- Life expectancy up to 5 million cycles
- Modular pressure vessel design
- AC and DC voltage compatible

## Technical Specifications

<b>Body Material</b>	<b>Anodized aluminum body, Stainless steel internals, FKM sealing material</b>
Coil Enclosures	DIN, NEMA 4 with cable gland connector
Coil Wattage	4.5 to 5.0 watt depending on voltage
Porting	1/8" NPT or G 1/8" pressure port (reference valve number). Banjo bolt G 1/8" or G 1/4" male thread
Mounting	Any position
Operating Characteristics	$\Delta P$ minimum 0 psid $\Delta P$ maximum 150psi
Max. Fluid Temperature	0°F (-18°C) to 185°F (85°C)
Ambient Temperature	14°F (-10°C) to 122°F (50°C)
Compatible Fluids	Dry or lubricated air
Agency Approvals/ Compliance	DIN Coils: UL recognized component for US & Canada

## Dimensions

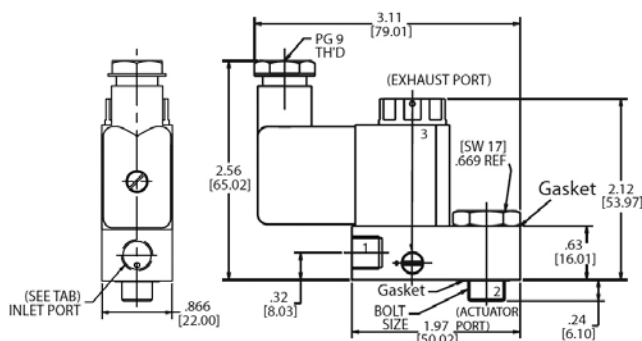

Dimensions are shown in inches and millimeters.

## Ordering Information

Part Number	Actuator Enclosure Port 2	Valve Pressure Port 1
U131B01NDAX	G 1/8"	1/8" NPT
U131B02NDAX	G 1/4"	1/8" NPT
131B03NDAX	G 1/8"	G 1/8"
131B04NDAX	G 1/4"	G 1/8"

### Voltage Code for Din Coil

A= 12VDC, B= 24VDC, E= 24/60, F= 120/60, 110/50, G= 240/60, 220/50  
Replace "x" in the Part number with one of the above Voltage Din Coil Codes.



# 3-Way Direct Acting Pilot Control Valves

Available as Separate Components

## 304 Series 3-Way Normally Closed Miniature Valves



### Voltage Codes for Coils

A= 12VDC, B= 24VDC,  
E= 24/60, F= 120/60, 110/50,  
G= 240/60, 220/50 - Replace  
"x" in the part number with one  
of the above Coil Voltage Codes

**Example: 30CC02EV4C4B** =  
1/8" 3-Way valve with 24VDC  
conduit coil

### Technical Specifications

Body Material	303 Stainless body, FKM sealing material
Coil Enclosures	Conduit, DIN (connector not included)
Coil Wattage	8.0 watts DC, 10 watts AC
Porting	1/8" NPT ports
Mounting	Any position
Operating Characteristics	$\Delta P$ minimum 0 psid $\Delta P$ maximum 200psi
Max. Fluid Temperature	240°F (115°C)
Ambient Temperature	-10°F (-23°C) to 135°F (57°C)
Compatible Fluids	Dry or lubricated air
Cv	0.05
Agency Approvals/ Compliance	UL Listed General Purpose valve, Certified for Canada

### Ordering Information

Size	Pressure Vessel	Conduit	DIN
1/8"	30CC02EV4	C4x	D6x

## 301LG Series 3-Way Normally Closed Valves



### Technical Specifications

Body Material	316 Stainless body, FKM sealing material
Coil Enclosures	DIN (connector not included)
Coil Wattage	10 watts
Porting	1/8" or 1/4" BSP ports
Mounting	Any position
Operating Characteristics	$\Delta P$ minimum 0 psid $\Delta P$ maximum 116 psi 1/8", 174 psi 1/4"
Fluid Temperature	14°F (-10°C) to 284°F (140°C)
Ambient Temperature	-14°F (-26°C) to 122°F (50°C)
Compatible Fluids	Dry or lubricated air
Cv	1/8" 0.07 inlet & exhaust, 1/4" 0.07 inlet & exhaust

### Ordering Information

Size	Part Number with 24 VDC DIN Coil	Part Number with 120/60, 115/50 DIN Coil
1/8"	301LG1GVG2DJB	301LG1GVG2DjxP8
1/4"	301LG2GVG7DJB	301LG2GVG7DjxP8

# 3-Way Direct Acting Pilot Control Valves

Available as Separate Components

## 7000 Series 3-Way Normally Closed Valves



### Voltage Codes for Coils

C1= 12VDC, C2= 24VDC,  
B2= 24/60, P3= 120/60, 110/50,  
Q3= 240/60, 220/50

Add "N0" to the pressure vessel and replace "xx" in the Part number with one of the above Coil Voltage Codes

### Example:

**7131KBN2JV00N0D100P3** =  
1/4" 3-Way valve with 120/60,  
110/50 DIN coil

## Technical Specifications

<b>Body Material</b>	<b>303 Stainless body, NBR sealing material</b>
Coil Enclosures	Conduit, DIN (connector not included)
Coil Wattage	10 watts
Porting	1/8" or 1/4" NPT ports
Mounting	Any position
Operating Characteristics	$\Delta P$ minimum 0 psid $\Delta P$ maximum 215 psi 1/8", 150 psi 1/4"
Max. Fluid Temperature	185°F (85°C)
Ambient Temperature	-20°F (-28°C) to 150°F (65°C)
Compatible Fluids	Dry or lubricated air
Cv	1/8" 0.11 inlet & 0.11 exhaust, 1/4" 0.17 inlet & 0.24 exhaust
Agency Approvals/ Compliance	UL Listed General Purpose valve

## Ordering Information

Size	Pressure Vessel	Conduit	DIN
1/8"	7131KBN1GV00	C111xx	D100xx
1/4"	7131KBN2JV00	C111xx	D100xx





# OFFER OF SALE – PARKER FLUID CONTROL DIVISION

The goods, services or work (referred to as the "Products") offered by **Parker-Hannifin Corporation**, its subsidiaries, groups, divisions, and authorized distributors ("Seller") are offered for sale at prices indicated in the offer, or as may be established by Seller. The offer to sell the Products and acceptance of Seller's offer by any customer ("Buyer") is contingent upon, and will be governed by all of the terms and conditions contained in this Offer of Sale. Buyer's order for any Products specified in Buyer's purchase document or Seller's offer, proposal or quote ("Quote") attached to the purchase order, when communicated to Seller verbally, or in writing, shall constitute acceptance of this offer.

1. **Terms and Conditions.** Seller's willingness to offer Products for sale or accept an order for Products is subject to the terms and conditions contained in this Offer of Sale or any newer version of the same, published by Seller electronically at [www.parker.com/saleterms/](http://www.parker.com/saleterms/). Seller objects to any contrary or additional terms or conditions of Buyer's order or any other document or other communication issued by Buyer.
2. **Price; Payment.** Prices stated on Seller's Quote are valid for thirty (30) days, except as explicitly otherwise stated therein, and do not include any sales, use, or other taxes or duties unless specifically stated. Seller reserves the right to modify prices to adjust for any raw material price fluctuations. Unless otherwise specified by Seller, all prices are F.C.A. Seller's facility (INCOTERMS 2010). Payment is subject to credit approval and payment for all purchases is due thirty (30) days from the date of invoice (or such date as may be specified by Seller's Credit Department). Unpaid invoices beyond the specified payment date incur interest at the rate of 1.5% per month or the maximum allowable rate under applicable law.
3. **Shipment; Delivery; Title and Risk of Loss.** All delivery dates are approximate. Seller is not responsible for damages resulting from any delay. Regardless of the manner of shipment, delivery occurs and title and risk of loss or damage pass to Buyer, upon placement of the Products with the shipment carrier at Seller's facility. Unless otherwise stated, Seller may exercise its judgment in choosing the carrier and means of delivery. No deferment of shipment at Buyer's request beyond the respective dates indicated will be made except on terms that will indemnify, defend and hold Seller harmless against all loss and additional expense. Buyer shall be responsible for any additional shipping charges incurred by Seller due to Buyer's acts or omissions.
4. **Warranty.** Seller warrants that the Products sold hereunder shall be free from defects in material or workmanship for a period of twenty four (24) months from the date of manufacture or 2,000 hours of normal use, whichever occurs first. Exception to this warranty is taken for the Angle Body Valve line which has a (12) month warranty. All prices are based upon the exclusive limited warranty stated above, and upon the following disclaimer: **DISCLAIMER OF WARRANTY: THIS WARRANTY IS THE SOLE AND ENTIRE WARRANTY PERTAINING TO PRODUCTS PROVIDED. SELLER DISCLAIMS ALL OTHER WARRANTIES, EXPRESS AND IMPLIED, INCLUDING DESIGN, MERCHANTABILITY AND FITNESS FOR A PARTICULAR PURPOSE.**
5. **Claims; Commencement of Actions.** Buyer shall promptly inspect all Products upon receipt. No claims for shortages will be allowed unless reported to the Seller within ten (10) days of delivery. No other claims against Seller will be allowed unless asserted in writing within thirty (30) days after delivery. Buyer shall notify Seller of any alleged breach of warranty within thirty (30) days after the date the defect is or should have been discovered by Buyer. Any claim or action against Seller based upon breach of contract or any other theory, including tort, negligence, or otherwise must be commenced within twelve (12) months from the date of the alleged breach or other alleged event, without regard to the date of discovery.
6. **LIMITATION OF LIABILITY.** IN THE EVENT OF A BREACH OF WARRANTY, SELLER WILL, AT ITS OPTION, REPAIR OR REPLACE A DEFECTIVE PRODUCT, OR REFUND THE PURCHASE PRICE WITHIN A REASONABLE PERIOD OF TIME. **IN NO EVENT IS SELLER LIABLE FOR ANY SPECIAL, INDIRECT, INCIDENTAL OR CONSEQUENTIAL DAMAGES ARISING OUT OF, OR AS THE RESULT OF, THE SALE, DELIVERY, NON-DELIVERY, SERVICING, USE OR LOSS OF USE OF THE PRODUCTS OR ANY PART THEREOF, OR FOR ANY CHARGES OR EXPENSES OF ANY NATURE INCURRED WITHOUT SELLER'S WRITTEN CONSENT, WHETHER BASED IN CONTRACT, TORT OR OTHER LEGAL THEORY. IN NO EVENT SHALL SELLER'S LIABILITY UNDER ANY CLAIM MADE BY BUYER EXCEED THE PURCHASE PRICE OF THE PRODUCTS.**
7. **User Responsibility.** The user, through its own analysis and testing, is solely responsible for making the final selection of the system and Product and assuring that all performance, endurance, maintenance, safety and warning requirements of the application are met. The user must analyze all aspects of the application and follow applicable industry standards and Product information. If Seller provides Product or system options based upon data or specifications provided by the user, the user is responsible for determining that such data and specifications are suitable and sufficient for all applications and reasonably foreseeable uses of the Products or systems.
8. **Loss to Buyer's Property.** Any designs, tools, patterns, materials, drawings, confidential information or equipment furnished by Buyer or any other items which become Buyer's property, will be considered obsolete and may be destroyed by Seller after two (2) consecutive years have elapsed without Buyer ordering the items manufactured using such property. Seller shall not be responsible for any loss or damage to such property while it is in Seller's possession or control.
9. **Special Tooling.** A tooling charge may be imposed for any special tooling, including without limitation, dies, fixtures, molds and patterns, acquired to manufacture Products. Such special tooling shall be and remain Seller's property notwithstanding payment of any charges by Buyer. In no event will Buyer acquire any interest in apparatus belonging to Seller which is utilized in the manufacture of the Products, even if such apparatus has been specially converted or adapted for such manufacture and notwithstanding any charges paid by Buyer. Unless otherwise agreed, Seller has the right to alter, discard or otherwise dispose of any special tooling or other property in its sole discretion at any time.
10. **Buyer's Obligation; Rights of Seller.** To secure payment of all sums due or otherwise, Seller retains a security interest in all Products delivered to Buyer and this agreement is deemed to be a Security Agreement under the Uniform Commercial Code. Buyer authorizes Seller as its attorney to execute and file on Buyer's behalf all documents Seller deems necessary to perfect its security interest.
11. **Improper Use and Indemnity.** Buyer shall indemnify, defend, and hold Seller harmless from any losses, claims, liabilities, damages, lawsuits, judgments and costs (including attorney fees and defense costs), whether for personal injury, property damage, patent, trademark or copyright infringement or any other claim, brought by or incurred by Buyer, Buyer's employees, or any other person, arising out of: (a) improper selection, application, design, specification or other misuse of Products purchased by Buyer from Seller; (b) any act or omission, negligent or otherwise, of Buyer; (c) Seller's use of patterns, plans, drawings, or specifications furnished by Buyer to manufacture Products; or (d) Buyer's failure to comply with these terms and conditions. Seller shall not indemnify Buyer under any circumstance except as otherwise provided.
12. **Cancellations and Changes.** Buyer may not cancel or modify or cancel any order for any reason, except with Seller's written consent and upon terms that will indemnify, defend and hold Seller harmless against all direct, incidental and consequential loss or damage. Seller may change Product features, specifications, designs and availability.
13. **Limitation on Assignment.** Buyer may not assign its rights or obligations under this agreement without the prior written consent of Seller.
14. **Force Majeure.** Seller does not assume the risk and is not liable for delay or failure to perform any of Seller's obligations by reason of events or circumstances beyond its reasonable control (hereinafter "Events of Force Majeure"). Events of Force Majeure shall include without limitation: accidents, strikes or labor disputes, acts of any government or government agency, acts of nature, delays or failures in delivery from carriers or suppliers, shortages of materials, or any other cause beyond Seller's reasonable control.
15. **Waiver and Severability.** Failure to enforce any provision of this agreement will not invalidate that provision; nor will any such failure prejudice Seller's right to enforce that provision in the future. Invalidation of any provision of this agreement by legislation or other rule of law shall not invalidate any other provision herein. The remaining provisions of this agreement will remain in full force and effect.
16. **Termination.** Seller may terminate this agreement for any reason and at any time by giving Buyer thirty (30) days prior written notice. Seller may immediately terminate this agreement, in writing, if Buyer: (a) breaches any provision of this agreement (b) appoints a trustee, receiver or custodian for all or any part of Buyer's property (c) files a petition for relief in bankruptcy on its own behalf, or one if filed by a third party (d) makes an assignment for the benefit of creditors; or (e) dissolves its business or liquidates all or a majority of its assets.
17. **Governing Law.** This agreement and the sale and delivery of all Products are deemed to have taken place in, and shall be governed and construed in accordance with, the laws of the State of Ohio, as applicable to contracts executed and wholly performed therein and without regard to conflicts of laws principles. Buyer irrevocably agrees and consents to the exclusive jurisdiction and venue of the courts of Cuyahoga County, Ohio with respect to any dispute, controversy or claim arising out of or relating to this agreement.
18. **Indemnity for Infringement of Intellectual Property Rights.** Seller is not liable for infringement of any patents, trademarks, copyrights, trade dress, trade secrets or similar rights except as provided in this Section. Seller will defend and indemnify Buyer against allegations of infringement of U.S. patents, U.S. trademarks, copyrights, trade dress and trade secrets ("Intellectual Property Rights"). Seller will defend at its expense and will pay the cost of any settlement or damages awarded in an action brought against Buyer based on an allegation that a Product sold pursuant to this agreement infringes the Intellectual Property Rights of a third party. Seller's obligation to defend and indemnify Buyer is contingent on Buyer notifying Seller within ten (10) days after Buyer becomes aware of such allegations of infringement, and Seller having sole control over the defense of any allegations or actions including all negotiations for settlement or compromise. If a Product is subject to a claim that it infringes the Intellectual Property Rights of a third party, Seller may, at its sole expense and option, procure for Buyer the right to continue using the Product, replace or modify the Product so as to make it noninfringing, or offer to accept return of the Product and refund the purchase price less a reasonable allowance for depreciation. Notwithstanding the foregoing, Seller is not liable for claims of infringement based on information provided by Buyer, or directed to Products delivered hereunder for which the designs are specified in whole or part by Buyer, or infringements resulting from the modification, combination or use in a system of any Product sold hereunder. The foregoing provisions of this Section constitute Seller's sole and exclusive liability and Buyer's sole and exclusive remedy for infringement of Intellectual Property Rights.
19. **Entire Agreement.** This agreement contains the entire agreement between the Buyer and Seller and constitutes the final, complete and exclusive expression of the terms of sale. All prior or contemporaneous written or oral agreements or negotiations with respect to the subject matter are herein merged. The terms contained herein may not be modified unless in writing and signed by an authorized representative of Seller.
20. **Compliance with Laws.** Buyer agrees to comply with all applicable laws, regulations, and industry and professional standards of care, including those of the United Kingdom, the United States of America, and the country or countries in which Buyer may operate, including without limitation the U. K. Bribery Act, the U.S. Foreign Corrupt Practices Act ("FCPA"), the U.S. Anti-Kickback Act ("Anti-Kickback Act") and the U.S. Food Drug and Cosmetic Act ("FDCA"), each as currently amended, and the rules and regulations promulgated by the U.S. Food and Drug Administration ("FDA"), and agrees to indemnify and hold harmless Seller from the consequences of any violation of such provisions by Buyer, its employees or agents. Buyer acknowledges that it is familiar with the provisions of the U. K. Bribery Act, the FCPA, the FDA, and the Anti-Kickback Act, and certifies that Buyer will adhere to the requirements thereof. In particular, Buyer represents and agrees that Buyer will not make any payment or give anything of value, directly or indirectly to any governmental official, any foreign political party or official thereof, any candidate for foreign political office, or any commercial entity or person, for the purpose of influencing such person to purchase Products or otherwise benefit the business of Seller.



Parker Hannifin Corporation  
**Fluid Control Division**  
95 Edgewood Avenue  
New Britain, CT 06051  
phone 860 827 2300  
[www.parker.com/fcd](http://www.parker.com/fcd)

